

INSTRUKCJA MONTAŻU I ASSEMBLY INSTRUCTION

M-AS-040

2019.05

A metalowa obudowa półki z płyty x 1 szt
I walls for wooden shelf x 1 pc

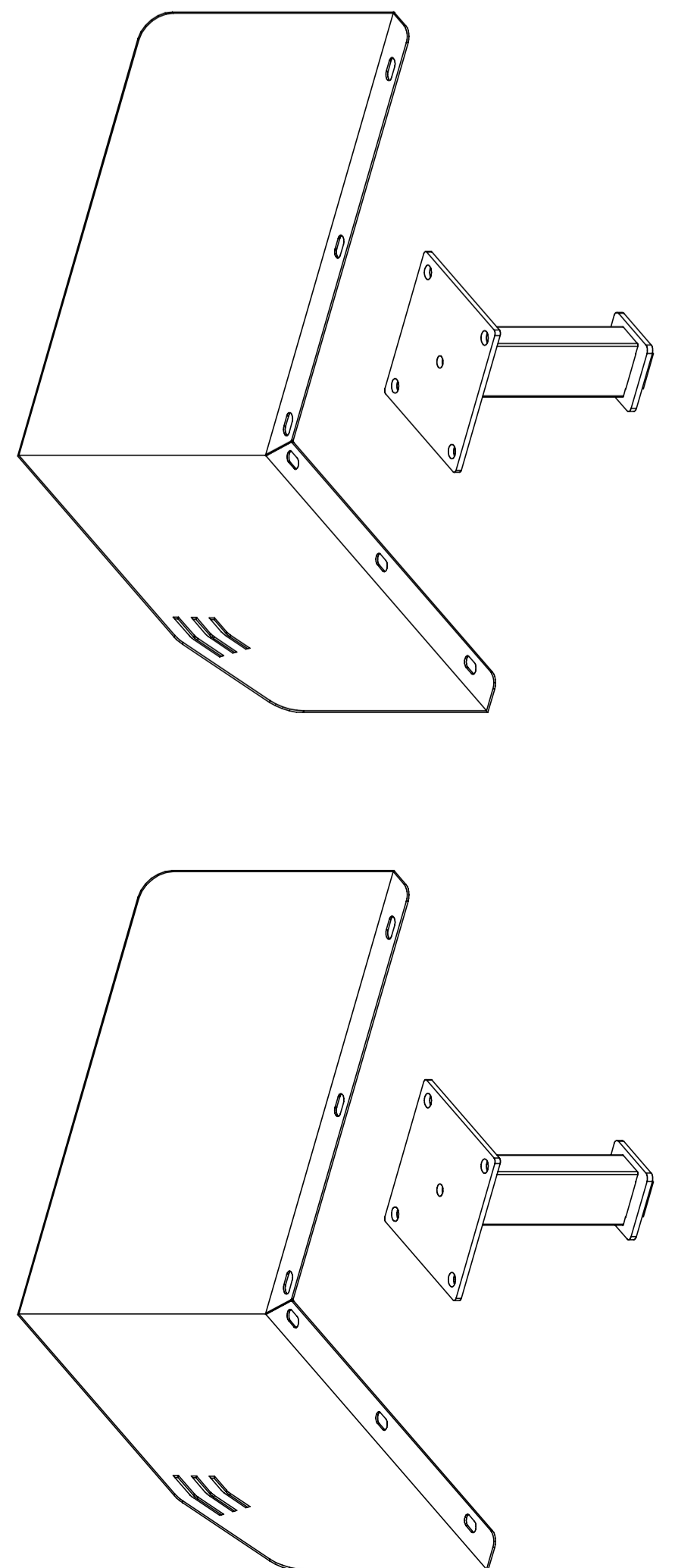

B wkręt x 12 szt I sharp screw x 12 pcs

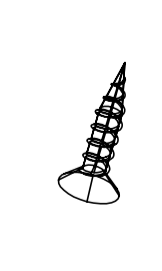

C wkręt x 8 szt I sharp screw x 8 pcs

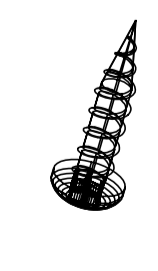

D płytka x 2 szt I plate x 2 pcs

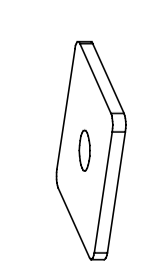

E śruba x 2 szt I screw x 2 pcs

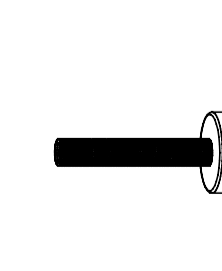

F klucz imbusowy x 1 szt I allen key x 1 pc

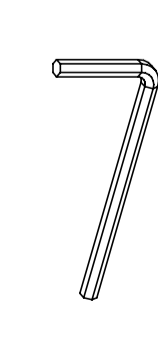

potrzebne narzędzia I necessary tools



1

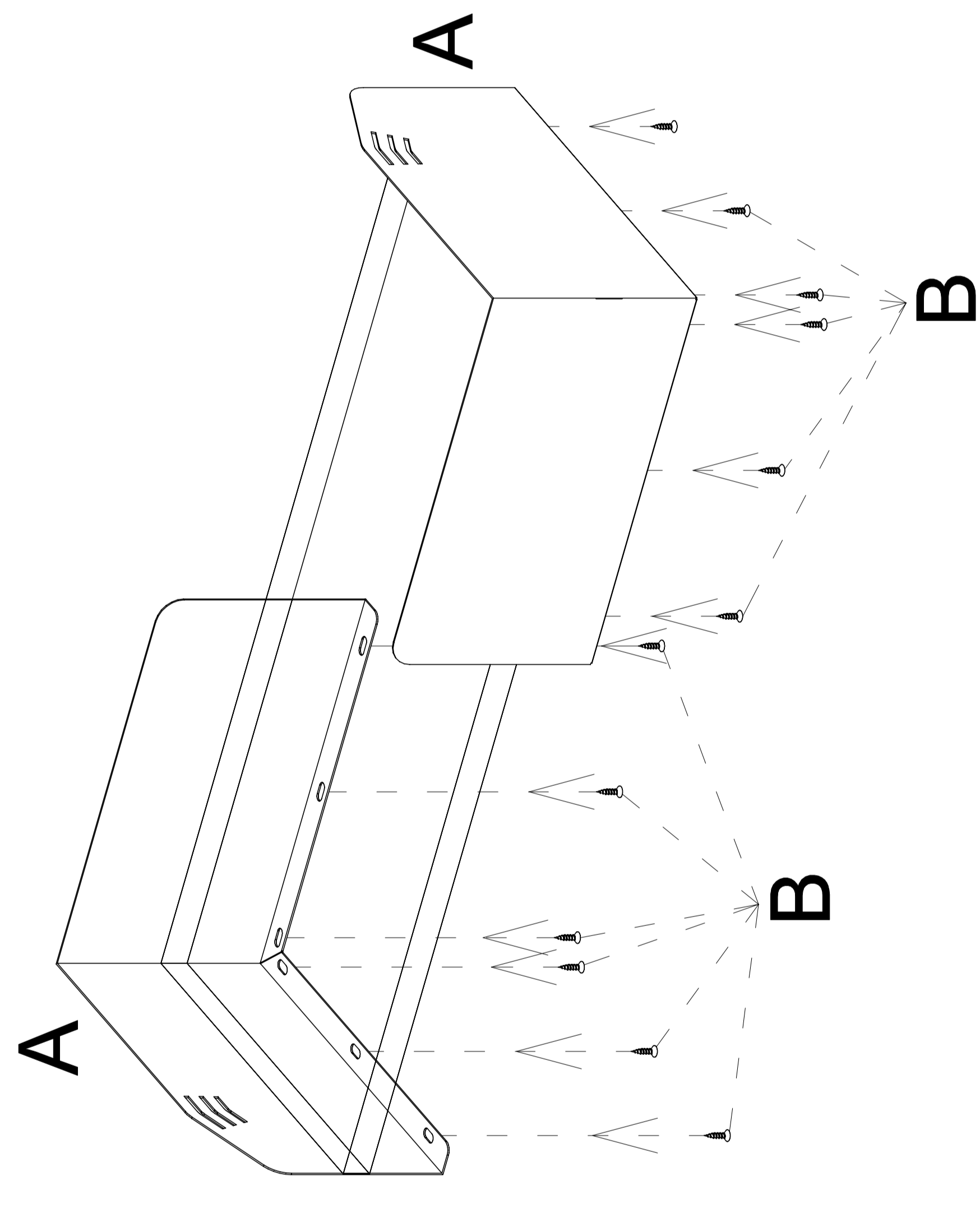

2

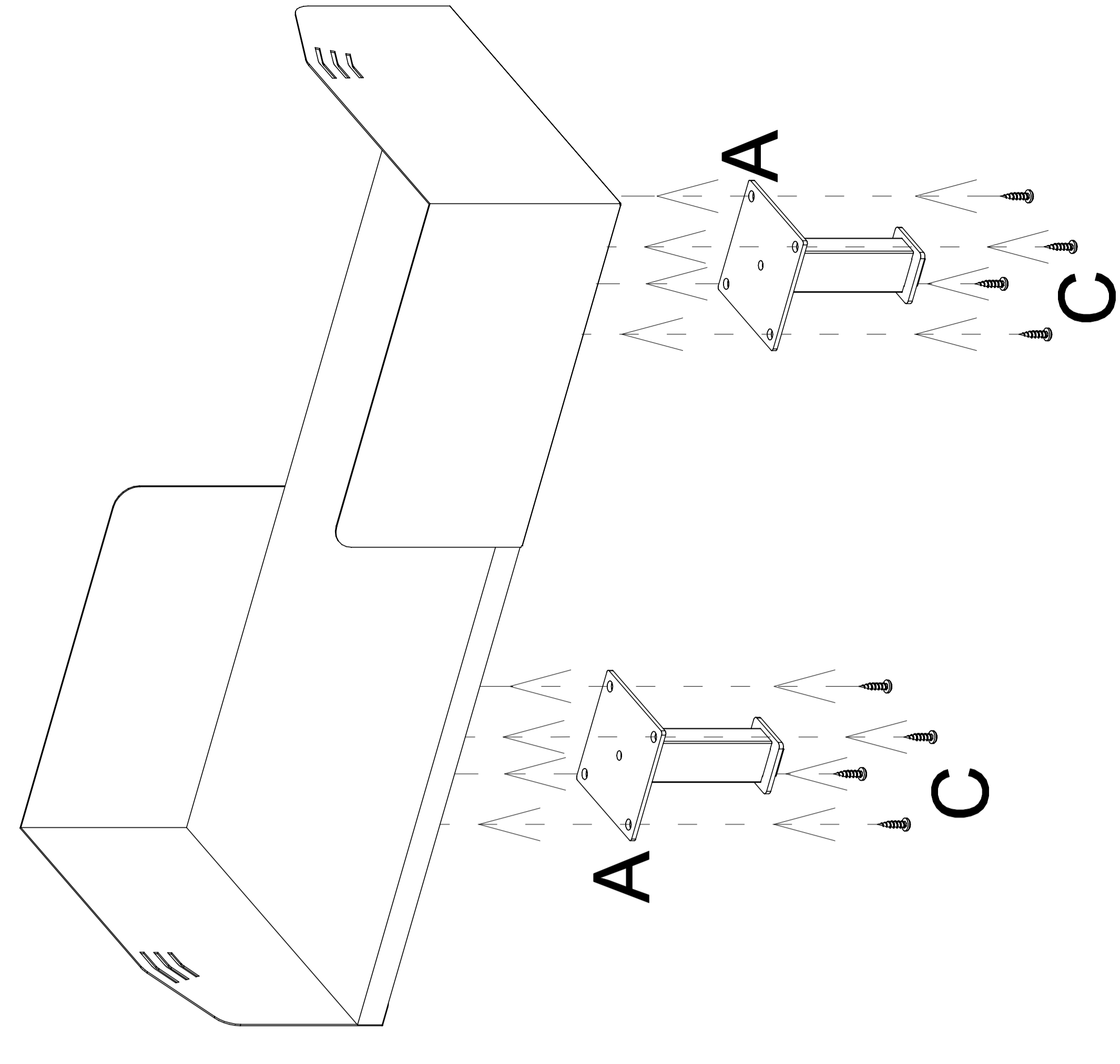

3

