

**A** noga x 1 szt | leg x 1 pc

A1

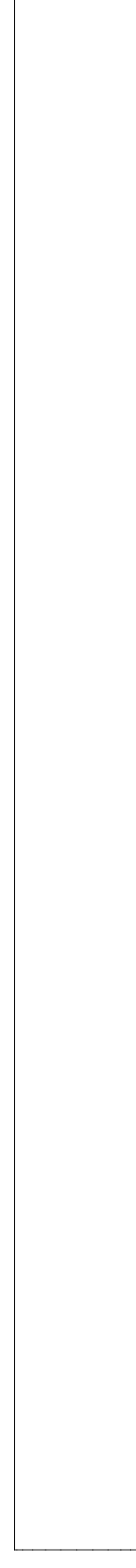

A2

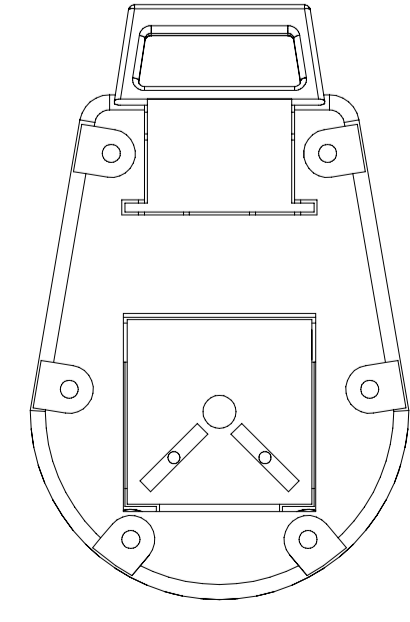

A3

**B** wkładka x 1 szt | insert x 1 pc

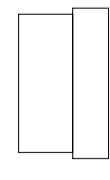

**C** regulator x 1 szt | adjustable feet x 1 pc

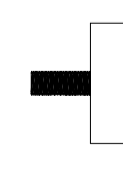

**D** klucz imbusowy x 1 szt | allen key x 1 pc

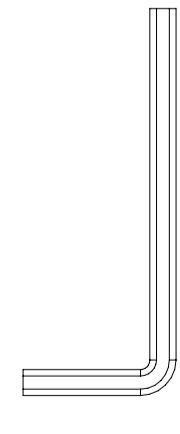

**E** śruba x 1 szt | screw x 1 pc

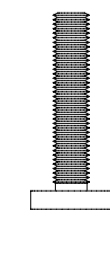

**F** wkręt x 6 szt | sharp screw x 6 pcs



potrzebne narzędzia | necessary tools



# INSTRUKCJA MONTAŻU | ASSEMBLY INSTRUCTION

## ST 506 W

2020.08

1

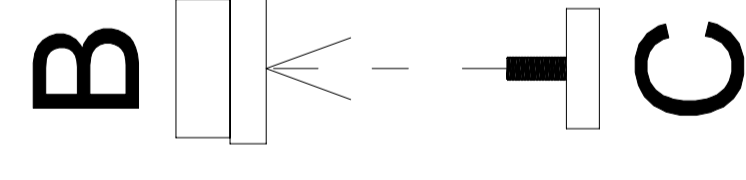

2

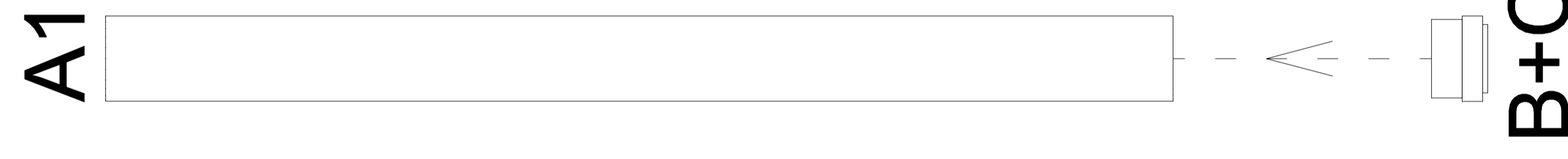

3

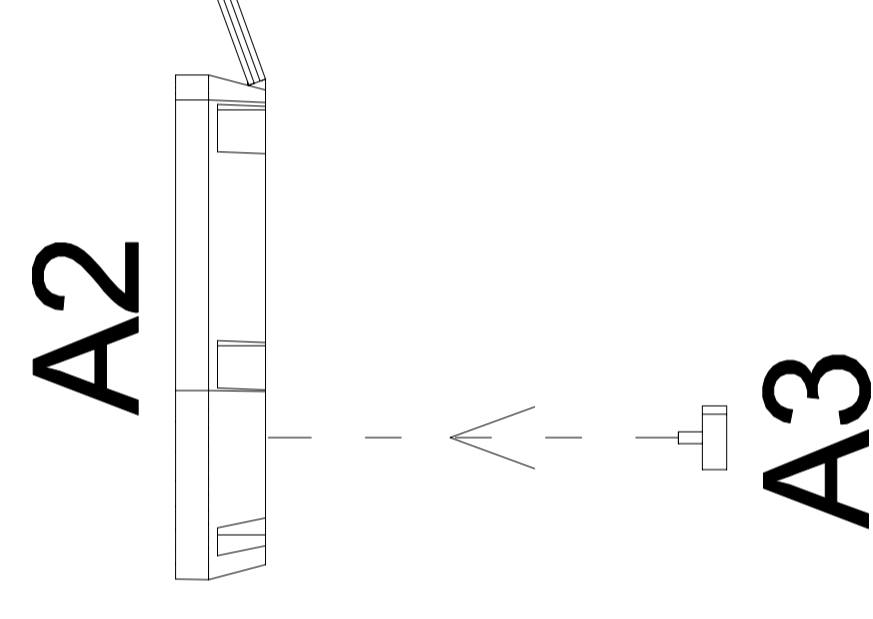

4

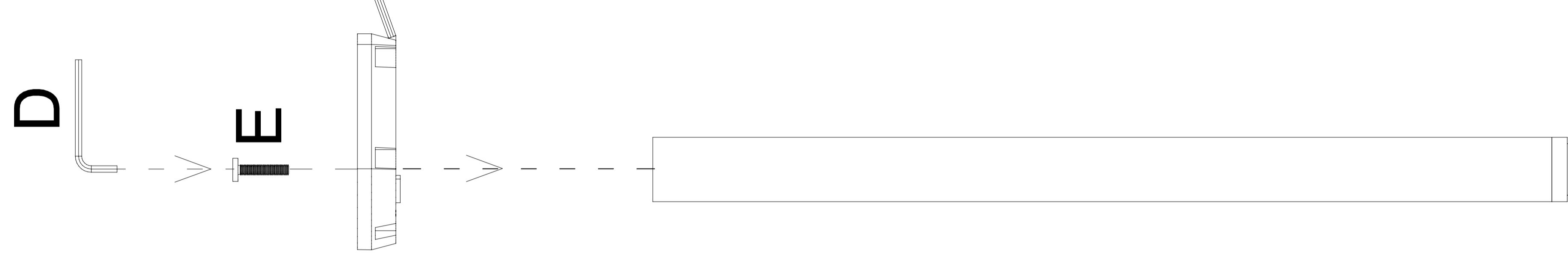

5

